

HERZ - Mosadzné tvarovky a tvarovky PPSU zo systému PipeFix

lisované a lisované závitové mosadzné tvarovky a lisované tvarovky PPSU

Technický list, vydanie 05 2022

Technické údaje

Pre plastliníkovú rúrku

Max. prevádzková teplota	+70°C až +90°C v závislosti od triedy aplikácie
Max. prevádzková teplota (max. 1 rok)	+95°C
Havarijná prevádzková teplota (max. 100 hodín)	+100°C
Min. prevádzková teplota	-20°C (pri montáži min. 0°C, so špeciálnymi bezpečnostnými opatreniami do -20°C)
Max. prevádzkový tlak	8 bar až 10 bar v závislosti od dimenzie
Max. prevádzkový tlak max. (1 rok)	12 bar
Materiál mosadzných tvaroviek	mosadz odolná voči vyplavovaniu zinku CW725R
Materiál PPSU tvaroviek	polymér
Materiál objímok (platí pre oba typy tvaroviek)	nehrdzavejúca oceľ
Životnosť	50 rokov (pri $T \leq 70^\circ\text{C}$)

Lisovacia čeluste TH, výrobca REMS (pozri výrobný program).

Axiálna sila lisovacích klieští: pri štandardných čelustiach - 34 kN, pri MINI čelustiach - 24 kN

Oblasť použitia

HERZ - Mosadzné tvarovky zo systému PipeFix sú určené pre použitie v systémoch vykurovania, chladenia a rozvodoch pitnej vody. Tvarovky PPSU zo systému PipeFix sú určené pre použitie v systémoch vykurovania a chladenia. Tvarovky sú testované a kompatibilné pre spojenie s plastliníkovými rúrkami HERZ zo systému HERZ PipeFix.

Podmienky pre zabudovanie tvaroviek

Lisované mosadzné tvarovky a tvarovky PPSU, môžu byť inštalované aj pod omietku, resp. v podlahe (vo Viedni v budovách s diaľkovým vykurovaním sú lisované spoje v podlahe zakázané). Pri zabudovaní lisovanej tvarovky do steny alebo do podlahy musí byť tvarovka galvanicky oddelená pomocou izolácie proti vlhkosti od muriva, resp. betónu, aby sa zabránilo jej korózii. Túto izoláciu je možné vykonať napríklad teplom zmráziteľnými materiálmi alebo antikorošnou páskou. V každom prípade musí existovať kompatibilita s materiálom rúrky a tvarovkou.

Lisované mosadzné tvarovky musia byť chránené pred stavebnými materiálmi obsahujúcimi rozpúšťadlá a pred zlúčeninami obsahujúcimi amoniak a chlór.

Lisované PPSU tvarovky musia byť chránené pred stavebnými materiálmi, farbami, penami, lepidlami atď., ktoré obsahujú rozpúšťadlá.

Recyklácia a likvidácia

Tvarovky a súvisiace prepravné obaly pozostávajú z väčšej časti z recyklovateľných surovín. Likvidácia tvaroviek a príslušenstva nesmie ohrozovať zdravie alebo životné prostredie. Musia byť dodržané národné právne predpisy pre správne zneškodnenie.

☑ Tlaková strata mosadzných a PPSU Tvaroviek

Pre zjednodušenie výpočtu tlakových strát potrubných rozvodov sa hodnota tlakovej straty mosadzných tvaroviek aj tvaroviek PPSU (hodnota je rovnaká pri oboch typoch tvaroviek) určí ako ekvivalentná dĺžka potrubia. Túto dĺžku vyberieme z nasledujúcej tabuľky podľa dimenzie potrubia a pripočítame k dĺžke potrubia v danom úseku potrubného rozvodu.

Tlaková strata mosadzných a PPSU tvaroviek								
Dimenzia rúrky	Oblúk 45°	Koleno 90°	T-kus delenie	T-kus spojenie	T-kus protiprúd delenie	T-kus protiprúd spojenie	Priamy kus	Nástenka
Hodnoty tlakovej straty tvaroviek v ekvivalentnej dĺžke rúrky v metroch								
14	0,70	1,50	1,30	1,60	1,70	1,70	1,00	1,40
16	0,60	1,40	1,20	1,50	1,60	1,60	0,90	1,30
18	0,55	1,20	0,90	1,40	1,50	1,50	0,70	1,20
20	0,50	1,10	0,60	1,30	1,40	1,40	0,50	1,10
26	0,40	1,00	0,50	1,20	1,30	1,30	0,40	-
32	0,30	0,80	0,30	1,00	1,10	1,10	0,30	-
40	0,26	0,76	0,28	0,95	1,00	1,00	0,26	-
50	0,22	0,72	0,26	0,90	0,95	0,95	0,22	-
63	0,18	0,70	0,24	0,85	0,90	0,90	0,18	-

☑ Objednávkové čísla a rozmery mosadzných tvaroviek
HERZ Spojka

Obj. číslo	A	L	D	Z
	(mm)	(mm)	(mm)	(mm)
P 7016 00	16 x 2	58	23	5
P 7020 00	20 x 2	58	27	5
P 7026 00	26 x 3	65	33	9
P 7032 00	32 x 3	65	39	9
P 7040 00	40 x 3,5	65	47	9
P 7050 00	50 x 4	97	57	13
P 7063 00	63 x 4,5	98	70	13
P 7075 00	75 x 2	106	82	7

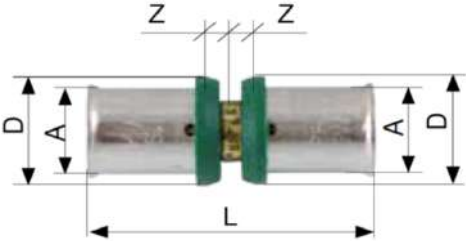

HERZ Záslepka

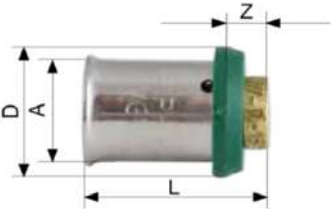
Obj. číslo	A	L	D	Z
	(mm)	(mm)	(mm)	(mm)
P 7016 10	16 x 2	31	23	7
P 7020 10	20 x 2	31	27	7
P 7026 10	26 x 3	33	33	9
P 7032 10	32 x 3	33	39	9
P 7040 10	40 x 3,5	33	47	9
P 7050 10	50 x 4	49	57	13
P 7063 10	63 x 4,5	49	70	13

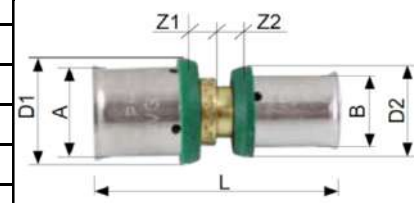

HERZ Redukcia

Obj. číslo	A	B	L	D1	D2	Z1	Z2
	(mm)	(mm)	(mm)	(mm)	(mm)	(mm)	(mm)
P 7020 01	20 x 2	16 x 2	62	27	23	7	7
P 7026 01	26 x 3	16 x 2	65	33	23	9	9
P 7026 02	26 x 3	20 x 2	65	33	27	9	9
P 7032 01	32 x 3	16 x 2	65	39	23	9	9
P 7032 02	32 x 3	20 x 2	65	39	27	9	9
P 7032 06	32 x 3	26 x 3	65	39	33	9	9
P 7040 02	40 x 3,5	26 x 3	65	47	33	9	9
P 7040 03	40 x 3,5	32 x 3	65	47	39	9	9
P 7050 01	50 x 4	26 x 3	81	57	33	13	9
P 7050 02	50 x 4	32 x 3	81	57	39	13	9
P 7050 03	50 x 4	40 x 3,5	81	57	47	13	9
P 7063 01	63 x 4,5	26 x 3	82	70	33	13	9
P 7063 02	63 x 4,5	32 x 3	82	70	39	13	9
P 7063 03	63 x 4,5	40 x 3,5	82	70	47	13	9
P 7063 04	63 x 4,5	50 x 4	98	70	57	13	13
P 7075 02	75 x 5	50 x 4	102	82	57	7	13
P 7075 01	75 x 5	63 x 4,5	102	82	70	7	13



HERZ Kolená 90°

Obj. číslo	A	L	H	D	Z
	(mm)	(mm)	(mm)	(mm)	(mm)
P 7116 00	16 x 2	39	39	23	15
P 7120 00	20 x 2	42	42	27	18
P 7126 00	26 x 3	51	51	33	27
P 7132 00	32 x 3	55	55	39	31
P 7140 00	40 x 3,5	58	58	47	34
P 7150 00	50 x 4	76	76	57	40
P 7163 00	63 x 4,5	83	83	70	47
P 7175 00	75 x 5	99	99	83	53

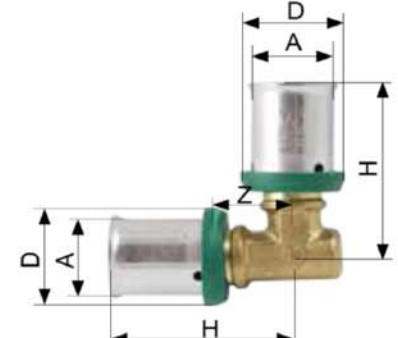

HERZ Oblúk 45°

Obj. číslo	A	H	D	Z
	(mm)	(mm)	(mm)	(mm)
P 7126 01	26 x 3	54	33	30
P 7132 01	32 x 3	56	39	32
P 7140 01	40 x 3,5	56	47	32
P 7150 01	50 x 4	78	57	35
P 7163 01	63 x 4,5	85	70	41

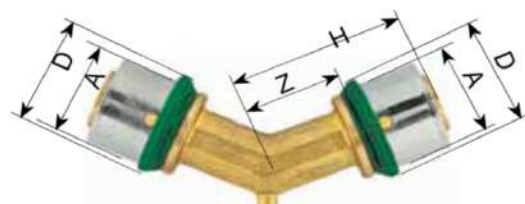

T-kus rovnoramenný

Obj. číslo	A	L	H	D	Z
	(mm)	(mm)	(mm)	(mm)	(mm)
P 7216 00	16 x 2	83	42	23	18
P 7220 00	20 x 2	83	42	27	18
P 7226 00	26 x 3	102	51	33	27
P 7232 00	32 x 3	106	53	39	29
P 7240 00	40 x 3,5	110	55	47	31
P 7250 00	50 x 4	152	76	57	40
P 7263 00	63 x 4,5	166	83	70	47
P 7275 00	75 x 5	198	99	83	53

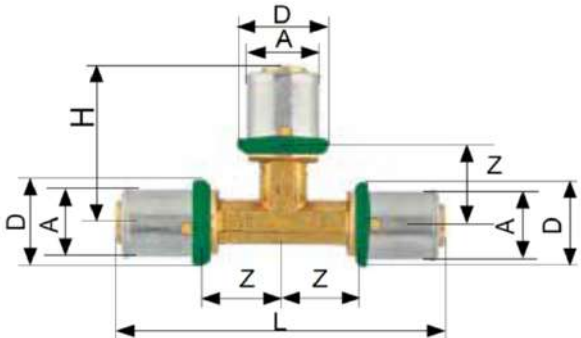
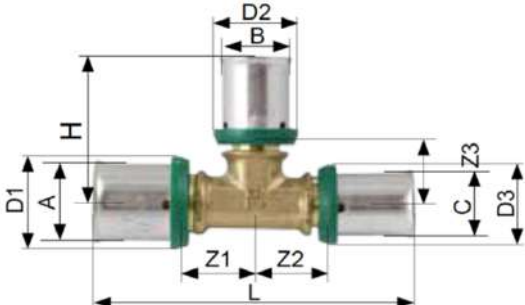
T-kus redukovaný

Obj. číslo	A	B	C	L	H	D1	D2	D3	Z1	Z2	Z3
	(mm)	(mm)	(mm)	(mm)	(mm)	(mm)	(mm)	(mm)	(mm)	(mm)	(mm)
P 7216 03	16 x 2	20 x 2	16 x 2	83	42	23	27	23	18	18	18
P 7220 03	20 x 2	16 x 2	16 x 2	83	42	27	23	23	18	18	18
P 7220 01	20 x 2	16 x 2	20 x 2	83	42	27	23	27	18	18	18
P 7220 08	20 x 2	20 x 2	16 x 2	83	42	27	27	23	18	18	18
P 7220 06	20 x 2	26 x 3	20 x 2	102	51	27	33	27	27	27	27
P 7226 21	26 x 3	16 x 2	16 x 2	95	48	33	23	23	25	25	25
P 7226 03	26 x 3	16 x 2	26 x 3	97	49	33	23	33	25	25	25
P 7226 13	26 x 3	20 x 2	16 x 2	102	51	33	27	23	27	27	27
P 7226 14	26 x 3	20 x 2	20 x 2	102	51	33	27	27	27	27	27
P 7226 05	26 x 3	20 x 2	26 x 3	97	49	33	27	33	25	25	25
P 7226 16	26 x 3	26 x 3	16 x 2	112	56	33	33	23	32	32	32
P 7226 15	26 x 3	26 x 3	20 x 2	112	56	33	33	27	32	32	32
P 7226 17	26 x 3	32 x 3	26 x 3	106	53	33	39	33	29	29	29
P 7232 01	32 x 3	16 x 2	32 x 3	106	53	39	23	39	29	29	29
P 7232 04	32 x 3	20 x 2	32 x 3	106	53	39	27	39	29	29	29
P 7232 11	32 x 3	20 x 2	26 x 3	106	53	39	27	33	29	29	29
P 7232 09	32 x 3	26 x 3	26 x 3	106	53	39	33	33	29	29	29
P 7232 07	32 x 3	26 x 3	32 x 3	106	53	39	33	39	29	29	29
P 7232 15	32 x 3	32 x 3	20 x 2	106	53	39	39	27	29	29	29
P 7232 14	32 x 3	32 x 3	26 x 3	106	53	39	39	33	29	29	29
P 7232 10	32 x 3	40 x 3,5	32 x 3	106	53	39	47	39	29	29	29

T-kus redukovaný

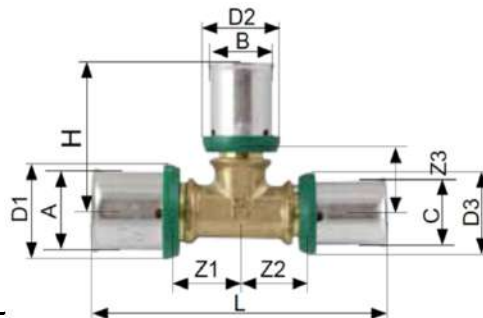

Obj. číslo	A	B	C	L	H	D1	D2	D3	Z1	Z2	Z3
	(mm)	(mm)	(mm)	(mm)	(mm)	(mm)	(mm)	(mm)	(mm)	(mm)	(mm)
P 7240 06	40 x 3,5	26 x 3	32 x 3	110	55	47	33	37	31	31	31
P 7240 02	40 x 3,5	26 x 3	40 x 3,5	110	55	47	33	47	31	31	31
P 7240 04	40 x 3,5	32 x 3	32 x 3	110	50	47	39	39	31	31	26
P 7240 03	40 x 3,5	32 x 3	40 x 3,5	110	55	47	39	47	31	31	31
P 7240 07	40 x 3,5	40 x 3,5	26 x 3	110	55	47	47	33	31	31	31
P 7240 08	40 x 3,5	40 x 3,5	32 x 3	110	55	47	47	39	31	31	31
P 7240 12	40 x 3,5	50 x 4	40 x 3,5	140	78	47	57	47	47	47	47
P 7250 03	50 x 4	26 x 3	50 x 4	152	62	57	33	57	40	40	38
P 7250 06	50 x 4	32 x 3	40 x 3,5	152	62	57	39	47	46	46	38
P 7250 01	50 x 4	32 x 3	50 x 4	152	62	57	37	57	40	40	38
P 7250 05	50 x 4	40 x 3,5	40 x 3,5	137	61	57	47	47	39	39	37
P 7250 02	50 x 4	40 x 3,5	50 x 4	152	59	57	47	57	40	40	35
P 7250 07	50 x 4	50 x 4	32 x 3	152	76	57	57	39	46	46	40
P 7250 08	50 x 4	50 x 4	40 x 3,5	152	76	57	57	47	46	46	40
P 7263 03	63 x 4,5	32 x 3	63 x 4,5	166	67	70	37	70	47	47	43
P 7263 04	63 x 4,5	40 x 3,5	50 x 4	166	67	70	47	57	47	47	43
P 7263 01	63 x 4,5	40 x 3,5	63 x 4,5	153	67	70	47	70	40	40	43
P 7263 05	63 x 4,5	50 x 4	50 x 4	166	83	70	57	57	47	47	47
P 7263 02	63 x 4,5	50 x 4	63 x 4,5	166	83	70	57	70	47	47	47
P 7263 06	63 x 4,5	63 x 4,5	40 x 3,5	150	83	70	70	47	45	45	47
P 7263 07	63 x 4,5	63 x 4,5	50 x 4	166	83	70	70	57	47	47	47
P 7263 07	63 x 4,5	63 x 4,5	50 x 4	166	83	70	70	57	47	47	47

T-kus s vonkajším závitom

Obj. číslo	A	B	L	H	D	Z
	(mm)	(mm)	(mm)	(mm)	(mm)	(mm)
P 7216 51	16 x 2	Rp 1/2	90	34	23	21
P 7220 51	20 x 2	Rp 1/2	91	34	27	22
P 7220 52	20 x 2	Rp 3/4	98	34	27	25
P 7226 51	26 x 3	Rp 1/2	112	38	33	32
P 7226 52	26 x 3	Rp 3/4	112	38	33	32
P 7226 53	26 x 3	Rp 1	112	43	33	32
P 7232 51	32 x 3	Rp 3/4	110	47	39	31
P 7232 52	32 x 3	Rp 1	110	47	39	31
P 7240 52	40 x 3,5	Rp 1	110	55	47	31
P 7240 53	40 x 3,5	Rp 1¼	110	55	47	31
P 7250 53	50 x 4	Rp 1¼	152	61	57	40
P 7250 54	50 x 4	Rp 1½	152	61	57	40
P 7263 55	63 x 4,5	Rp 2	166	70	70	47

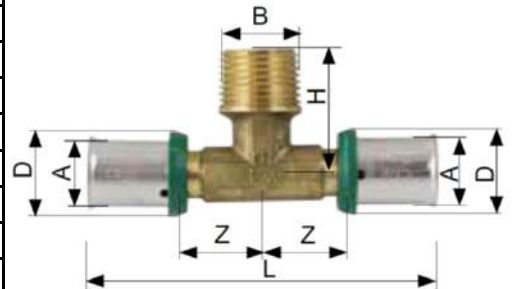

T-kus s vnútorným závitom

Obj. číslo	A	B	L	H	D	Z
	(mm)	(mm)	(mm)	(mm)	(mm)	(mm)
P 7216 41	16 x 2	Rp 1/2	90	34	23	21
P 7220 41	20 x 2	Rp 1/2	91	34	27	22
P 7220 42	20 x 2	Rp 3/4	112	43	27	32
P 7226 42	26 x 3	Rp 1/2	112	38	33	32
P 7226 41	26 x 3	Rp 1/2	112	37	33	32
P 7226 44	26 x 3	Rp 3/4	112	43	33	32
P 7232 43	32 x 3	Rp 1/2	110	47	39	31
P 7232 41	32 x 3	Rp 3/4	110	47	39	31
P 7232 42	32 x 3	Rp 1	110	47	39	31
P 7232 44	32 x 3	Rp 1¼	125	55	39	39
P 7240 41	40 x 3,5	Rp 1	110	55	47	31
P 7240 42	40 x 3,5	Rp 1¼	110	55	47	31
P 7250 42	50 x 4	Rp 1¼	152	63	57	40
P 7250 43	50 x 4	Rp 1½	152	63	57	40
P 7263 44	63 x 4,5	Rp 2	166	70	70	47

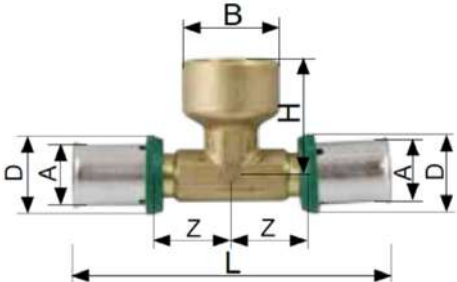
Prechodové koleno s vnútorným závitom

Obj. číslo	A	B	L	H	D	Z
	(mm)	(mm)	(mm)	(mm)	(mm)	(mm)
P 7116 21	16 x 2	Rp 1/2	44	34	23	20
P 7120 21	20 x 2	Rp 1/2	50	34	27	20
P 7120 22	20 x 2	Rp 3/4	52	45	27	28
P 7126 22	26 x 3	Rp 3/4	56	45	33	32
P 7132 23	32 x 3	Rp 1	55	49	39	31
P 7140 24	40 x 3,5	Rp 1¼	55	55	47	31
P 7150 24	50 x 4	Rp 1¼	76	63	57	40
P 7150 25	50 x 4	Rp 1½	76	63	57	40
P 7163 26	63 x 4,5	Rp 2	83	70	70	47

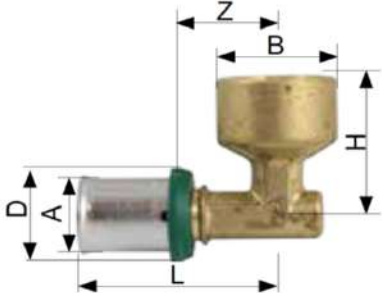

Prechodové koleno s vonkajším závitom

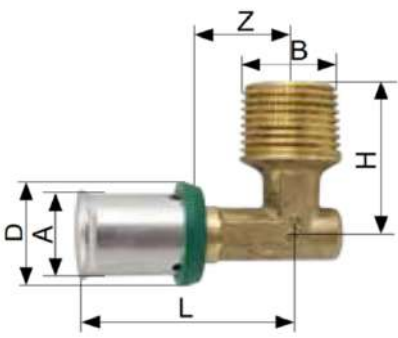
Obj. číslo	A	B	L	H	D	Z
	(mm)	(mm)	(mm)	(mm)	(mm)	(mm)
P 7116 11	16 x 2	Rp 1/2	44	34	23	20
P 7120 11	20 x 2	Rp 1/2	50	34	27	20
P 7120 12	20 x 2	Rp 3/4	52	45	27	20
P 7126 12	26 x 3	Rp 3/4	56	45	33	32
P 7132 13	32 x 3	Rp 1	55	49	39	23
P 7140 14	40 x 3,5	Rp 1¼	55	55	47	23
P 7150 14	50 x 4	Rp 1¼	76	63	57	40
P 7163 16	63 x 4,5	Rp 2	83	70	70	47

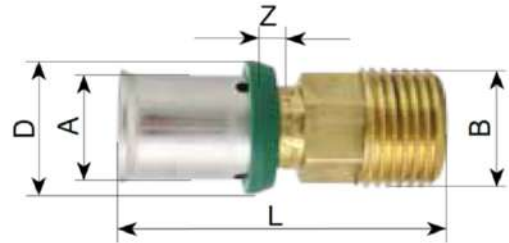

Prechod s vonkajším závitom

Obj. číslo	A	B	L	D	Z
	(mm)	(mm)	(mm)	(mm)	(mm)
P 7016 11	16 x 2	R 1/2	54	23	5
P 7016 12	16 x 2	R 3/4	54	23	5
P 7020 11	20 x 2	R 1/2	54	27	5
P 7020 12	20 x 2	R 3/4	54	27	5
P 7026 12	26 x 3	R 3/4	54	33	5
P 7026 13	26 x 3	R 1	54	33	5
P 7032 13	32 x 3	R 1	54	39	5
P 7032 14	32 x 3	R 1¼	54	39	5
P 7040 13	40 x 3,5	R 1	59	47	5
P 7040 14	40 x 3,5	R 1¼	59	47	5
P 7050 14	50 x 4	R 1¼	83	57	12
P 7050 15	50 x 4	R 1½	83	57	12
P 7063 16	63 x 4,5	R 2	92	70	12
P 7075 16	75 x 5	R 2	96	83	12
P 7075 18	75 x 5	R 2½	96	83	12



Prechod s vnútorným závitom

Obj. číslo	A	B	L	D	Z
	(mm)	(mm)	(mm)	(mm)	(mm)
P 7016 21	16 x 2	Rp 1/2	53	23	5
P 7020 21	20 x 2	Rp 1/2	53	27	5
P 7020 22	20 x 2	Rp 3/4	55	27	5
P 7026 22	26 x 3	Rp 3/4	55	33	5
P 7026 23	26 x 3	Rp 1	56	33	5
P 7032 23	32 x 3	Rp 1	56	39	5
P 7032 24	32 x 3	Rp 1¼	64	39	5
P 7040 23	40 x 3,5	Rp 1	56	47	7
P 7040 24	40 x 3,5	Rp 1¼	64	47	7
P 7050 24	50 x 4	Rp 1¼	76	57	12
P 7050 25	50 x 4	Rp 1½	76	57	12
P 7063 26	63 x 4,5	Rp 2	92	70	12

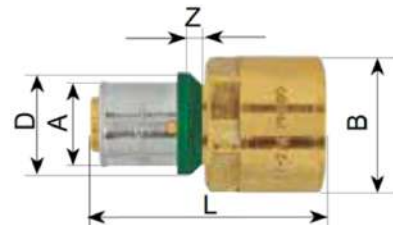

Prechodový závitový spoj s kužeľovým tesnením

Obj. číslo	A	B	L	D	Z
	(mm)	(mm)	(mm)	(mm)	(mm)
P 7016 81	16 x 2	G 3/4	27	23	50
P 7020 81	20 x 2	G 3/4	27	27	50

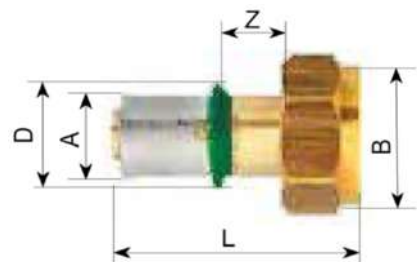

Prechodový závitový spoj s plochým tesnením

Obj. číslo	A	B	L	D	Z
	(mm)	(mm)	(mm)	(mm)	(mm)
P 7016 41	16 x 2	G 3/4	42	23	19
P 7016 42	16 x 2	G 1	35	23	12
P 7020 41	20 x 2	G 3/4	42	27	19
P 7020 42	20 x 2	G 1	35	27	12
P 7026 41	26 x 3	G 3/4	42	33	19
P 7026 42	26 x 3	G 1	35	33	12
P 7026 43	26 x 3	G 1¼	35	33	12
P 7032 42	32 x 3	G 1	46	35	23
P 7032 43	32 x 3	G 1¼	35	39	12
P 7032 44	32 x 3	G 1½	36	39	14
P 7040 44	40 x 3,5	G 1½	47	47	24
P 7040 43	40 x 3,5	G 1¼	43	47	21
P 7040 45	40 x 3,5	G 2	38	47	15
P 7050 44	50 x 4	G 1½	75	57	32
P 7050 45	50 x 4	G 2	75	57	32

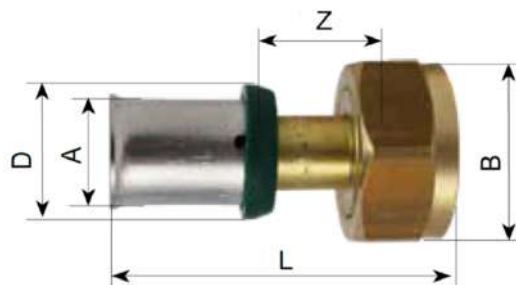
Prechodový závitový spoj s kužeľovým tesnením, ponikovaný

Obj. číslo	A	B	L	D	Z
	(mm)	(mm)	(mm)	(mm)	(mm)
P 7016 86	16 x 2	M 22 x 1,5	25	23	47
P 7016 90	16 x 2	G 1/2	25	23	47
P 7016 82	16 x 2	G 3/4	25	23	47
P 7020 90	20 x 2	G 1/2	27	27	50
P 7020 82	20 x 2	G 3/4	27	27	50

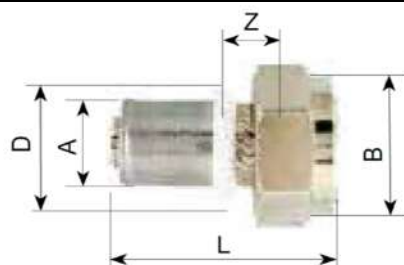
Prechodové závitové koleno s kužeľovým tesnením, ponikované

Obj. číslo	A	B	L	H	D	Z
	(mm)	(mm)	(mm)	(mm)	(mm)	(mm)
P 7116 14	16 x 2	G 3/4	44	33	23	22
P 7120 14	20 x 2	G 3/4	44	33	27	22

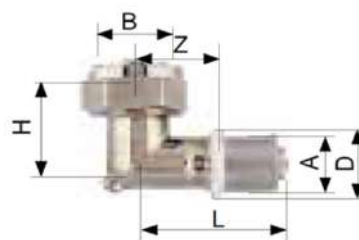

Prechod s plochým tesnením

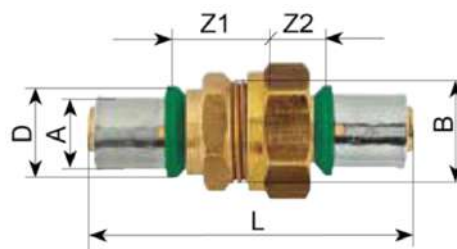
Obj. číslo	A	B	L	D	Z1	Z2
	(mm)	(mm)	(mm)	(mm)	(mm)	(mm)
P 7016 51	16 x 2	G 3/4	90	23	27	19
P 7020 51	20 x 2	G 3/4	90	27	27	19
P 7026 52	26 x 3	G 1	85	33	27	12
P 7032 53	32 x 3	G 1¼	85	39	27	12
P 7040 53	40 x 3,5	G 1¼	93	47	27	21
P 7050 55	50 x 4	G 2	157	57	36	32

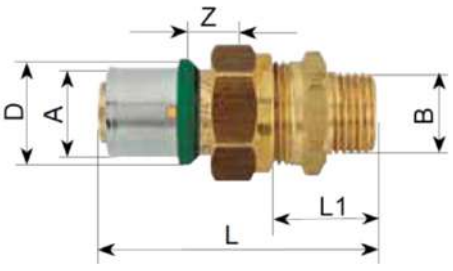

Prechod s plochým tesnením a vonkajším závitom

Obj. číslo	A	B	L	D	Z	L1
	(mm)	(mm)	(mm)	(mm)	(mm)	(mm)
P 7016 61	16 x 2	R 1/2	75	23	12	33
P 7016 62	16 x 2	R 3/4	61	23	19	33
P 7020 61	20 x 2	R 1/2	75	27	12	33
P 7020 62	20 x 2	R 3/4	61	27	19	33
P 7026 62	26 x 3	R 3/4	61	33	19	33
P 7026 63	26 x 3	R 1	71	33	35	36
P 7032 63	32 x 3	R 1	71	39	35	36
P 7040 64	40 x 3,5	R 1¼	86	47	43	43
P 7050 65	50 x 4	R 1½	119	57	75	44
P 7063 66	63 x 4,5	R 2	119	70	75	44



Prechod s plochým tesnením a vnútorným závitom

Obj. číslo	A	B	L	L1	D	Z
	(mm)	(mm)	(mm)	(mm)	(mm)	(mm)
P 7016 71	16 x 2	Rp 1/2	72	30	23	19
P 7016 72	16 x 2	Rp 3/4	72	30	23	19
P 7020 71	20 x 2	Rp 1/2	72	30	27	19
P 7020 72	20 x 2	Rp 3/4	72	30	27	19
P 7026 72	26 x 3	Rp 3/4	72	30	33	19
P 7026 73	26 x 3	Rp 1	70	35	33	12
P 7032 73	32 x 3	Rp 1	70	35	39	12
P 7040 74	40 x 3,5	Rp 1¼	86	43	47	21
P 7050 75	50 x 4	Rp 1½	120	45	57	32
P 7063 76	63 x 4,5	Rp 2	121	45	70	32

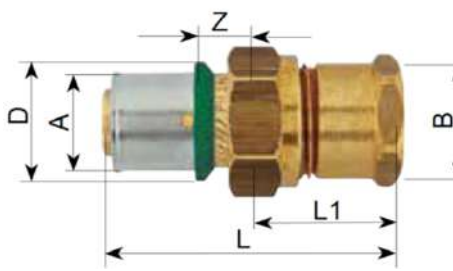

Koleno so závitovým pripojením s vonkajším závitom

Obj. číslo	A	B	L	H	D	Z	L1
	(mm)	(mm)	(mm)	(mm)	(mm)	(mm)	(mm)
P 7116 71	16 x 2	R 1/2	67	44	23	20	33
P 7120 71	20 x 2	R 1/2	67	46	27	20	33
P 7120 72	20 x 2	R 3/4	67	46	27	20	33
P 7126 73	26 x 3	R 1	79	46	33	27	36
P 7132 74	32 x 3	R 1¼	95	55	39	31	43

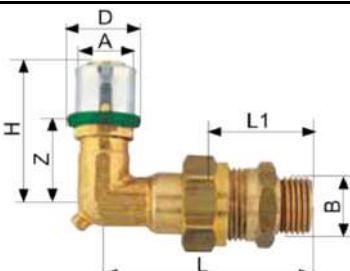

Koleno so závitovým pripojením s vnútorným závitom

Obj. číslo	A	B	L	H	D	Z	L1
	(mm)	(mm)	(mm)	(mm)	(mm)	(mm)	(mm)
P 7116 81	16 x 2	R 1/2	64	44	23	20	30
P 7120 81	20 x 2	R 1/2	64	46	27	20	30
P 7120 82	20 x 2	R 3/4	64	46	27	20	30
P 7126 83	26 x 3	R 1	80	46	33	27	35
P 7132 84	32 x 3	R 1¼	95	55	39	31	43

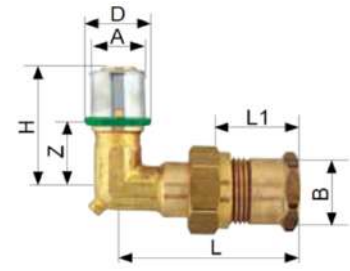

T-kus bez križovania

Obj. číslo	H	h	B	L	I
	(mm)	(mm)	(mm)	(mm)	(mm)
P 7200 31	99	50	Rp 1/2	120	50

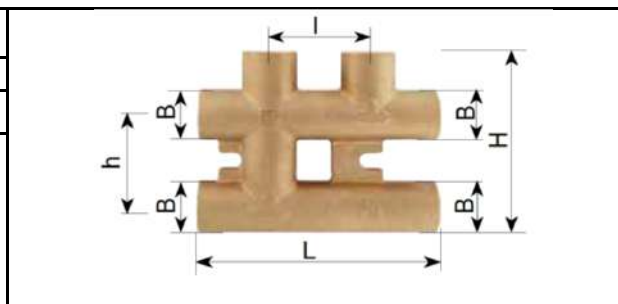
Teplnoizolačný obal pre T-kus bez križovania

Obj. číslo	A	B	H
	(mm)	(mm)	(mm)
P 1020 21	120	120	60

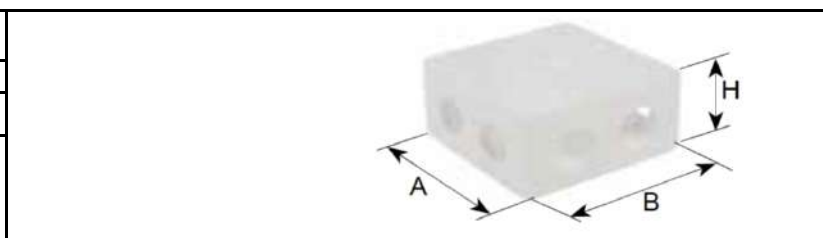
Závitová spojka pre T-kus bez križovania

Obj. číslo	A	B	L	D1	Z
	(mm)	(mm)	(mm)	(mm)	(mm)
P 7016 18	16 x 2	G 1/2	46	23	5
P 7020 18	20 x 2	G 1/2	46	27	5
P 7026 18	26 x 3	G 1/2	46	33	5

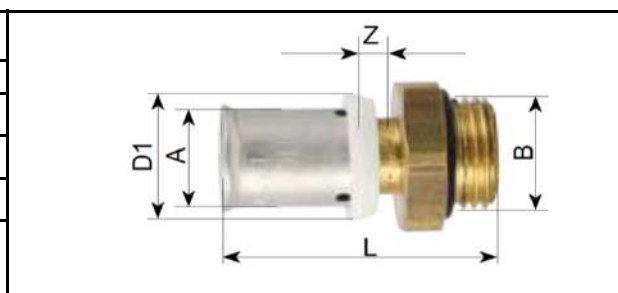
Nástenka krátka

Obj. číslo	A	D	B	L	H1	H2	Z
	(mm)	(mm)	(mm)	(mm)	(mm)	(mm)	(mm)
P 7116 31	16 x 2	23	Rp 1/2	44	52	17	22
P 7120 31	20 x 2	27	Rp 1/2	44	52	17	22
P 7120 32	20 x 2	27	Rp 3/4	50	53	21	28
P 7126 32	26 x 3	33	Rp 3/4	50	53	21	28

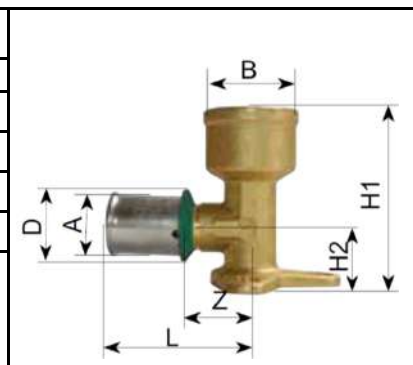
Nástenka dvojité

Obj. číslo	A	B	D	L1	L2	Z	X
	(mm)	(mm)	(mm)	(mm)	(mm)	(mm)	(mm)
P 7116 36	16 x 2,0	Rp 1/2	23	50	82	34	40
P 7120 36	20 x 2,0	Rp 1/2	27	50	82	34	40

Celková hrúbka pri obidvoch obj.č. je 39 mm



Nástenka dlhá

Obj. číslo	A	D	B	L	H1	H2	Z
	(mm)	(mm)	(mm)	(mm)	(mm)	(mm)	(mm)
P 7116 41	16 x 2	23	Rp 1/2	45	61	78	21
P 7120 41	20 x 2	27	Rp 1/2	45	61	78	21

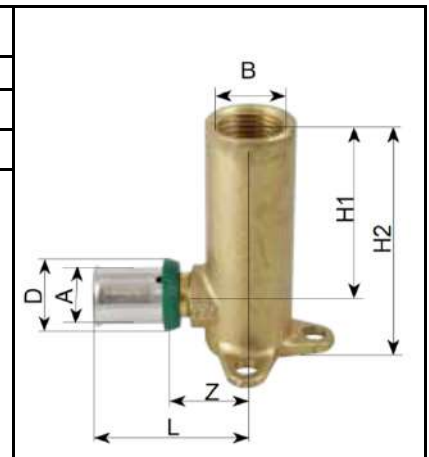

Stenová prechodka

Obj. číslo	A	D	B	L	H1	H2	Z
	(mm)	(mm)	(mm)	(mm)	(mm)	(mm)	(mm)
P 7116 51	16 x 2	23	Rp 1/2	46	52	18	25
P 7116 52	16 x 2	23	Rp 1/2	46	78	17	25
P 7120 52	20 x 2	27	Rp 1/2	46	78	17	25

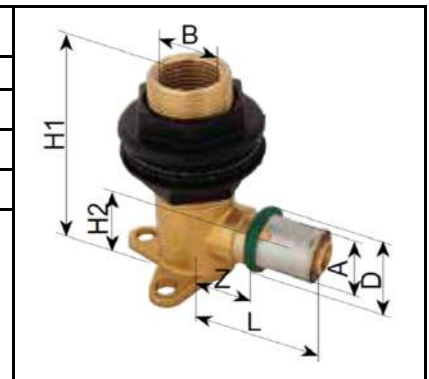

T-kus pre montáž nádrže splachovača pod omietku

Obj. číslo	A	B	L	H	D	Z
	(mm)	(mm)	(mm)	(mm)	(mm)	(mm)
P 7216 61	16 x 2	Rp 1/2	120	28	23	32
P 7220 61	20 x 2	Rp 1/2	120	28	27	32

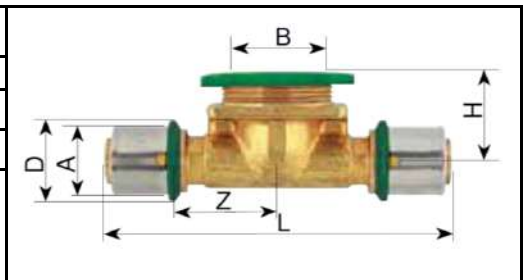

Koleno pre montáž nádrže splachovača pod omietku

Obj. číslo	A	B	L	H	D	Z
	(mm)	(mm)	(mm)	(mm)	(mm)	(mm)
P 7116 61	16 x 2	Rp 1/2	55	28	23	20
P 7120 61	20 x 2	Rp 1/2	55	28	27	20

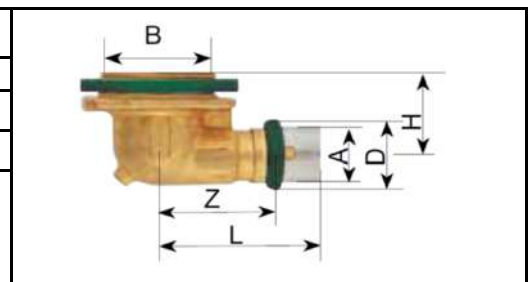

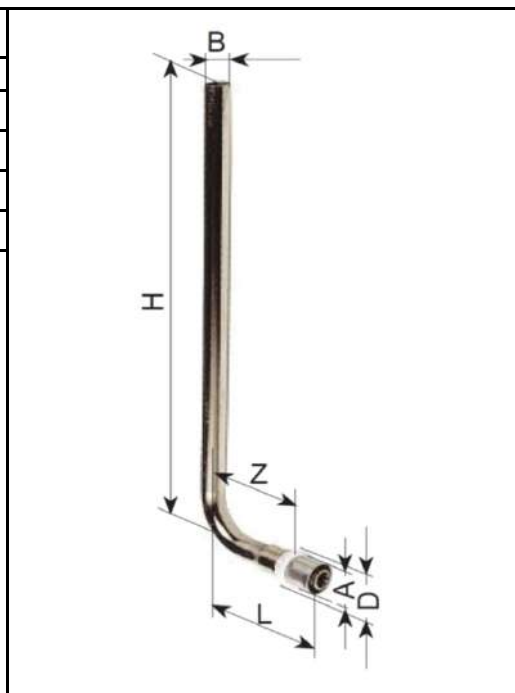

Pripojenie vykurovacích telies, koleno poniklované

Obj. číslo	A	D	Z	B	H	L
	(mm)	(mm)	(mm)	(mm)	(mm)	(mm)
P 7216 91	16x2	23	68	15	300	90
P 7216 92	16x2	23	68	15	1100	90
P 7220 91	20x2	27	68	15	300	90
P7220 92	20x2	27	68	15	1100	90

Pripojenie vykurovacích telies, koleno poniklované

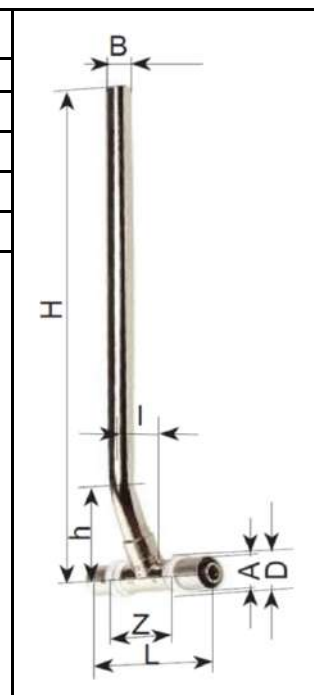
Obj. číslo	A	D	Z	B	H	h	L	I
	(mm)	(mm)	(mm)	(mm)	(mm)	(mm)	(mm)	(mm)
P 7116 91	16x2	23	39	15	300	50	82	20
P 7116 92	16x2	23	39	15	1100	50	82	20
P 7120 91	20x2	27	39	15	300	50	82	20
P 7120 92	20x2	27	39	15	1100	50	82	20



 Objednávkové čísla a rozmery tvaroviek PPSU

T-kus rovnoramenný

Obj. číslo	A	L	H	D1	Z1	Z2	Z3
	(mm)	(mm)	(mm)	(mm)	(mm)	(mm)	(mm)
R 6216 00	16 x 2	80	40	23	17	17	17
R 6220 00	20 x 2	86	43	27	20	20	20
R 6226 00	26 x 3	94	47	33	24	24	24

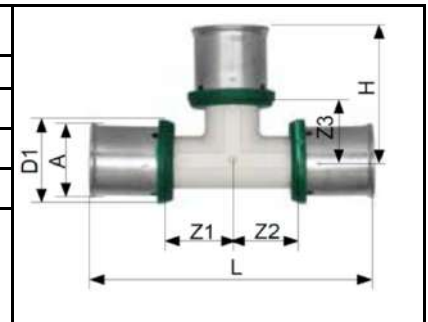

T-kus stredná vetva redukovaná

Obj. číslo	A	B	C	L	H	D1	D2	Z1	Z2	Z3
	(mm)	(mm)	(mm)	(mm)	(mm)	(mm)	(mm)	(mm)	(mm)	(mm)
R 6220 01	20 x 2	16 x 2	20 x 2	80	43	27	23	17	17	43
R 6226 03	26 x 3	16 x 2	26 x 3	86	47	33	23	17	12	47
R 6226 05	26 x 3	20 x 2	26 x 3	94	47	33	27	20	20	47

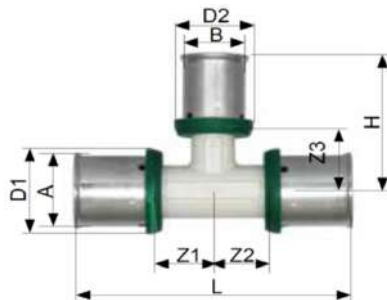

T-kus redukovaný

Obj. číslo	A	B	C	L	H	D1	D2	D3	Z1	Z2	Z3
	(mm)	(mm)	(mm)	(mm)	(mm)	(mm)	(mm)	(mm)	(mm)	(mm)	(mm)
R 6216 03	16 x 2	20 x 2	16 x 2	86	40	23	27	23	20	20	17
R 6220 03	20 x 2	16 x 2	16 x 2	80	43	27	23	23	17	17	20
R 6220 08	20 x 2	20 x 2	16 x 2	86	43	27	27	23	20	20	20
R 6220 06	20 x 2	26 x 3	20 x 2	94	43	27	33	27	24	24	20
R 6226 11	26 x 3	16 x 2	20 x 2	80	47	33	23	27	17	17	24
R 6226 13	26 x 3	20 x 2	16 x 2	86	47	33	27	23	20	20	24
R 6226 14	26 x 3	20 x 2	20 x 2	86	47	33	27	27	20	20	24
R 6226 16	26 x 3	26 x 3	16 x 2	94	47	33	33	23	24	24	24
R 6226 15	26 x 3	26 x 3	20 x 2	94	47	33	33	27	24	24	24

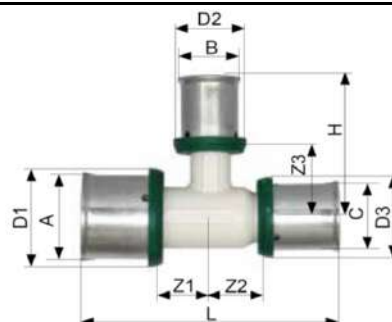

Koleno 90°

Obj. číslo	A	L	H	D1	Z
	(mm)	(mm)	(mm)	(mm)	(mm)
R 6116 00	16 x 2	40	40	23	17
R 6120 00	20 x 2	43	43	27	20
R 6126 00	26 x 3	47	47	33	24

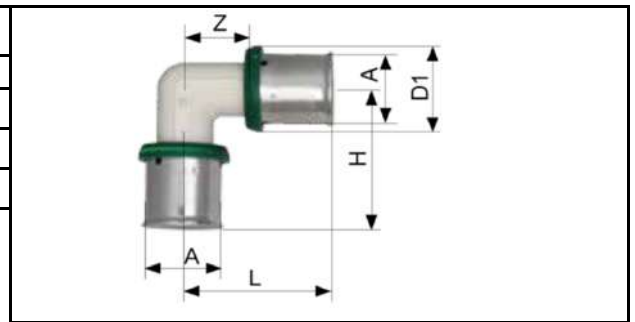
Spojka

Obj. číslo	A	L	D1	Z1	Z2
	(mm)	(mm)	(mm)	(mm)	(mm)
R 6016 00	16 x 2	54	23	4	4
R 6020 00	20 x 2	54	27	4	4
R 6026 00	26 x 3	54	33	4	4

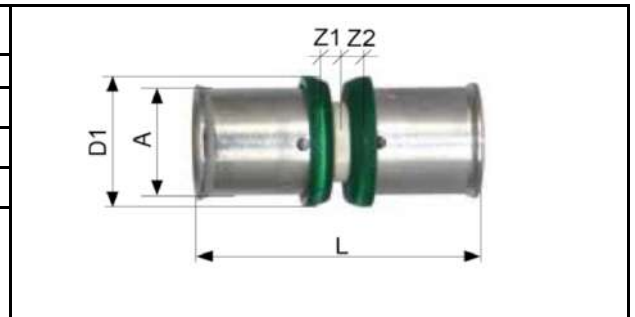
Redukcia

Obj. číslo	A	B	L	D1	D2	Z1	Z2
	(mm)	(mm)	(mm)	(mm)	(mm)	(mm)	(mm)
R 6020 01	20 x 2	16 x 2	54	27	23	4	4
R 6026 01	26 x 3	16 x 2	54	33	23	4	4
R 6026 02	26 x 3	20 x 2	54	33	27	4	4



Všetky v tomto dokumente obsiahnuté údaje zodpovedajú v čase vydania predloženým informáciám a nemusia byť úplné. Zmeny v zmysle technického pokroku sú vyhradené. Vyobrazenia sú len symbolické a preto opticky sa od skutočných výrobkov môžu odlišovať. Možné farebné odchýlky sú zapríčinené tlačou. V závislosti od krajiny sú možné aj rozdielne vyhotovenia produktu. Zmeny technických špecifikácií a funkčnosti sú vyhradené. V prípade akýchkoľvek otázok ohľadne produktov kontaktujte prosím najbližšiu pobočku spoločnosti HERZ.

☑ Montáž - spojenie HERZ Plastliníkovej rúrky s HERZ PipeFix Tvarovkami

1. Odrezanie rúrky

Pomocou vhodného nástroja rúrku odrežeme pod pravým uhlom.

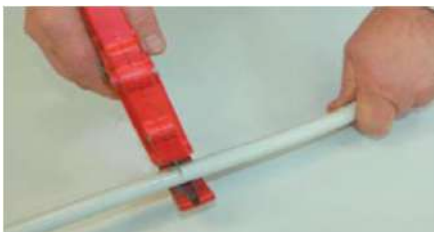

2. Odhrotovanie rúrky

Rúrku odhrotujeme na okrajoch a vykalibrujeme nástrojom hodiacim sa k jej priemeru. Z konca rúrky odstránime špony. Pri uchytení kalibrovacieho nástroja do vrtačky maximálny počet otáčok nesmie prekročiť 10U/min.



3. Nasunutie tvarovky na rúrku

Nasunieme tvarovku na rúrku. Skontrolujeme správnu polohu rúrky v otvoroch lisovacej objímky - rúrka musí siahať až na dozar v tvarovke a musí byť viditeľná v otvoroch tvarovky.



4. Zalisovanie tvarovky

Pomocou lisovacieho nástroja alebo ručných lisovacích klieští vytvoríme lisovaný spoj. Rúry musia byť bez napätia. Lisovanie je ukončené keď sa čeluste úplne uzavrú.



5. Min. vzdialenosť rúrky od steny/podlahy

HERZ PipeFix systém lisujeme "TH" čelustami, akumulátorovými alebo ručnými kliešťami. V tabuľke sú uvedené min. vzdialenosti rúrky od steny, resp. podlahy, aby sme mohli tvarovku na rúrku zalisovať.

DN	A (mm)	DN	A (mm)	DN	A (mm)
10	25	20	30	40	40
14	25	26	30	50	70
16	25	32	40	63	70

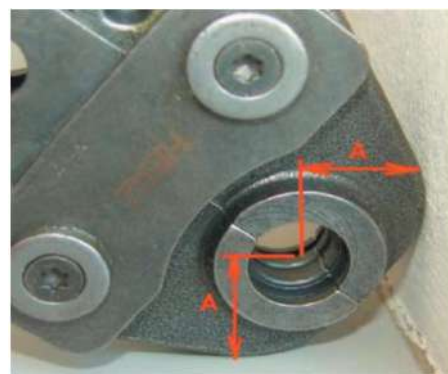

6. Kontrola spoja

Na obvode lisovacej objímky pozorujeme dve rovnobežné kruhové stopy po zalisovaní. Medzi nimi je vykľutenie. V otvoroch lisovacej objímky vidíme rúrku (biela farba). Spoj je správne zalisovaný.

